

MEJIBO

Formwork Joint Bar

MEJIBO, designed by Fukuvi Chemical Industry to create perfectly straight and clean grooves in cement/mortar walls during construction, makes the entire process easy and convenient, thanks to its PVC composition and prefabricated mounting holes. Manufactured from PVC, MEJIBO is durable, lightweight, easy to handle, doesn't absorb moisture and doesn't deform, unlike the industry standard wooden joint bars. The prefabricated mounting holes allow for easy installation, which saves our customers time during construction. MEJIBO is available in multiple design variations which provide our customers the flexibility to accommodate different designs in their projects. High quality materials and strict quality control, used in the manufacturing of the product, ensure longevity and reliability our customers can depend on. Meticulously designed and tested to meet the rules and regulations, and the high expectations of the international market.



Features



Quick Installation

Easy 4-Step Installation
Prefab mounting holes allow for easy mounting to surface



Lightweight

Lightweight PVC composition makes for easy handling



PVC

Made of PVC material with stable physical properties



Waterproof + Deformationproof

Does not absorb water, preventing deformation of the joint bar, for a perfect finish



Easy to Demold

Demolds quickly and in one piece, unlike a wood joint bar, making the finish process simple



Clean/Straight Lines

Helps create perfectly straight & clean lines at the install location



MADE IN VIETNAM



Product Page



Product List

Model	Design	Dimensions	Color	MOQ
M-15V	see page 2	2,000mm	Gray	100pcs
M-20V		2,000mm		100pcs
M-25V		2,000mm		50pcs
K-15V		2,000mm		100pcs
K-20V		2,000mm		100pcs

Model Design

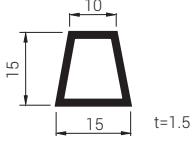
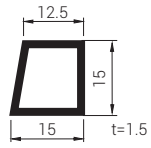
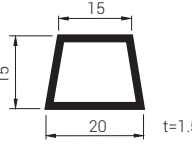
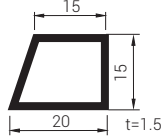
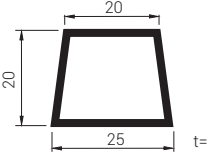
Model	Design	Model	Design
M-15V		K-15V	
M-20V		K-20V	
M-25V			

Installation Guide



Installation Video

1

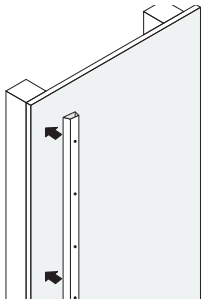

Secure MEJIBO to the plywood with screws.

2

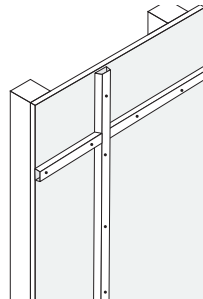

Secure MEJIBO to all desired locations.

3

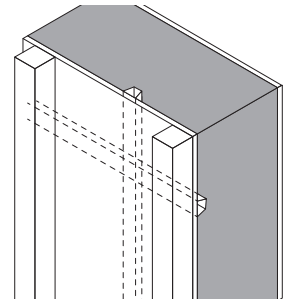

Apply concrete/mortar to wall.

4

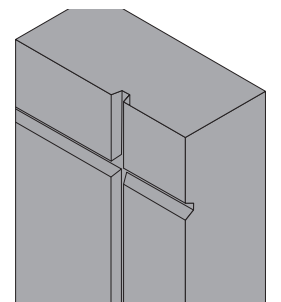

Finish by demolding the MEJIBO.

